

32 m ↑
14,3 m →
330 Kg* 👤👤👤

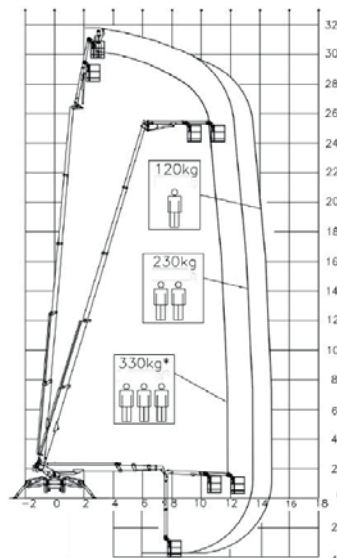

*optional

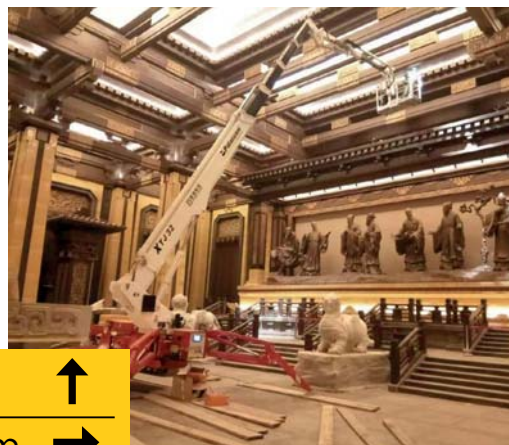
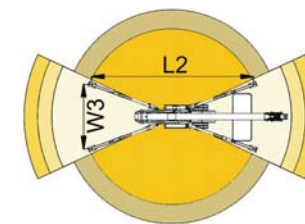
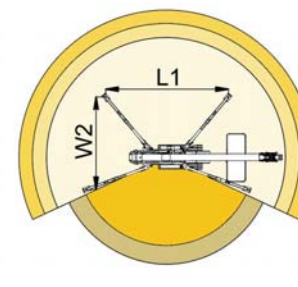
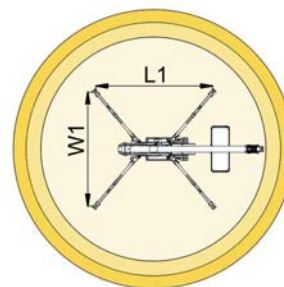
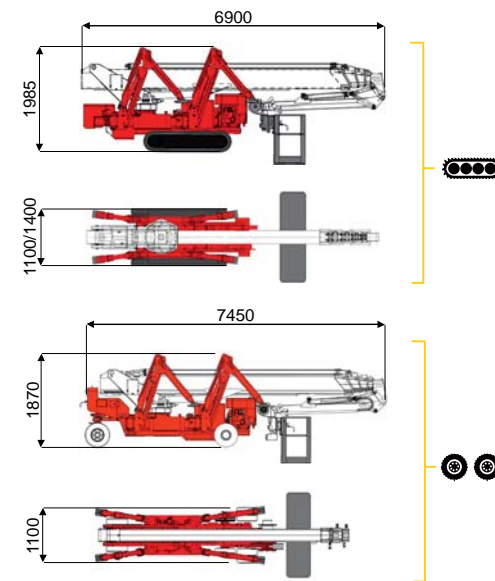

11,7 m	13,3 m	14,3 m	8,4 m	10 m	L1	L2	W1	W2	W3
330 kg*	230 kg	120 kg	330 kg*	120/230 kg	5125 mm	6460 mm	4760 mm	3785 mm	2820 mm

BI-ENERGY
Diesel+AC

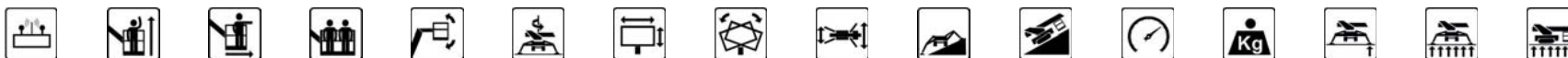

XTJ 32/C	🚫	32 m	14,3 m	330 kg*	170°	660°	180x70 cm	90°+80°	2,82-4,76 m	16%	38%	3 km/h	5940 kg	35 kN	2,43 kN/m ²	4,78 kN/m ²
XTJ 32/R	🚫🚫	32 m	14,3 m	330 kg*	170°	660°	180x70 cm	90°+80°	2,82-4,76 m	16%	18%	2 km/h	5940 kg	35 kN	2,43 kN/m ²	4,43 kN/m ²

Available version:

- BI-ENERGY (DIESEL+AC)
- ECO (DC+AC)
- HYBRID (DIESEL+DC)

Characteristics and technical data are informative only and subjected to change without notice.